



Degradation kinetics of ascorbic acid during ohmic heating with stainless steel electrodes

A. ASSIRY², S.K. SASTRY^{1,*} and C. SAMARANAYAKE¹

¹Department of Food, Agricultural and Biological Engineering, The Ohio State University, 590 Woody Hayes Drive, Columbus, OH 43210, USA

²King Saud University, PO Box 2480, Riyadh 11451, Saudi Arabia

(*author for correspondence)

Received 18 September 2000; accepted in revised form 10 December 2002

Key words: ascorbic acid, degradation kinetics, high frequency power control, inert electrode coatings

Abstract

Ascorbic acid degradation experiments were performed in buffer solution at pH 3.5 using a batch ohmic heater with uncoated stainless steel electrodes. The electrical conductivity of the buffer solution was adjusted using sodium chloride. The concentration of ascorbic acid was found using an HPLC technique. Kinetics of degradation can be described adequately by a first order model for both conventional and ohmic treatments, but unlike conventional heating, the temperature dependence of degradation for some ohmic treatments cannot be represented by the Arrhenius relation. During ohmic heating, power, temperature and NaCl content affect the degradation rate. A number of reactions, including electrode reactions, electrolysis of the solution, as well as reactions between electrode materials and electrolysis products may influence the reaction mechanism as well as kinetic parameters. At the highest power and salt content, citrate complexation and a significant loss of buffering capacity were noted, resulting in an increase in pH. The results underline the importance of inert electrode coatings, or the use of high frequency power for control of electrochemical reactions.

List of symbols

σ	electrical conductivity (mS cm^{-1})
A_c	cross-section area of current path in the cell (cm^2)
C	concentration of ascorbic acid at time t (mol cm^{-3})
C_0	Initial concentration of ascorbic acid (mol cm^{-3})
CI	confidence interval
E_T	temperature coefficient (kJ mol^{-1})
I	current (A)
k	rate constant for ascorbic acid degradation (min^{-1})
k_0	frequency factor (min^{-1})
k_c	ohmic heater (cell) constant (0.078 cm^{-1})
L	path length of current in cell (cm)
P	electrical power (W)
R	gas constant ($8.3143 \text{ kJ mol}^{-1} \text{ K}^{-1}$)
t	time (s)
T	temperature ($^{\circ}\text{C}$)
V	voltage (V)
[NaCl]	sodium chloride concentration (g per 100 ml)

1. Introduction

In recent years, electrical methods of food processing have gained increasing industry interest. Beginning in the 1980s with ohmic heating [1], to the current intense activity of pulsed electric field processes [2], these methods have gained renewed attention in an effort to improve product quality. A number of studies have addressed the basic engineering and heat transfer aspects of the ohmic process, for example, [3, 4]. However, the electrochemical aspects of such processes have been restricted to a few studies [5, 6]. In particular, an area that has not received attention has been the influence of ohmic processes on reaction kinetics within food systems. Although food chemists have studied various biochemical reactions and reaction rates over the years, the influence of electric fields has not received attention.

Ascorbic acid or vitamin C is considered to be one of the most heat sensitive nutrients in foods [7]. Its degradation has been reported to vary with temperature, pH, oxygen, enzymes, metal catalysts, initial concentration and light [8, 9]. Losses of such sensitive nutrients

during processing is of great concern. To minimize nutrient degradation, a kinetic model is necessary. Temperature effects can be described by the Arrhenius plot, with the activation energy (temperature coefficient) depending on the other chemical and physical properties of the reaction environment [8]. The degradation reaction may follow various pseudo-orders depending on the environment, however most common reactions can be described by a first order model. Lee et al. [10] determined the reaction order of ascorbic acid degradation in tomato juice under anaerobic conditions to be first order with respect to concentration. Dennison and Kirk [11] studied the oxygen effect in a dehydrated food system. They found that reaction rates were dependent on water activity and temperature and the reaction order was described by first order kinetics. Saguy et al. [12] studied the kinetics of ascorbic acid degradation in grapefruit juice. Their results indicated an apparent first order anaerobic reaction which was dependent on temperature and solid content but not on the initial ascorbic acid concentration. Degradation kinetics of ascorbic acid in potato strips was investigated during blanching by Kincal and Giray [13]; their results indicated that first order kinetics was appropriate. Unlike the above studies, [10–13] a zero order kinetic model was found to be adequate to describe the disappearance of ascorbic acid in an intermediate moisture model food system [14]. Also, a study by Eison–Perchonok and Downes [9] showed that the kinetics of ascorbic acid autoxidation, as a function of dissolved oxygen concentration and temperature, could be described by a second order (first order each in ascorbic acid and oxygen concentrations) reaction model. All the above studies related to the

degradation of ascorbic acid under conventional heating, and so far no similar information has been found under ohmic heating in buffer systems. The kinetics may differ as the heating mechanism differs; in particular the effect of an electrical field needs to be understood.

The objective of this study was to compare the degradation kinetics of ascorbic acid in a 3.5 pH buffer solution under conventional and ohmic heating in a stirred ohmic heater with stainless steel electrodes. Although a wide variety of electrode materials could have been studied, stainless steel was studied due to its widespread use as a food contact surface. In particular, the effects of temperature, electrical conductivity and the applied electrical power were investigated. This system is much simpler than a real food system, and is therefore expected to be more amenable to analysis. The choice of pH was dictated by a value representative of acidic foods, which are typically easier to process than foods characterized as 'low-acid' (pH > 4.6).

2. Materials and methods

2.1. Experimental set-up

Experiments were performed in a batch isothermal stirred reactor, with ohmic heating at 60 Hz. The setup, modified from Palaniappan et al. [15] is shown in Figure 1. Temperature inside the ohmic heater was controlled to ± 2 °C. The cell constant of the ohmic heater ($k_c = L/A_c$) was 0.078 cm^{-1} when filled to a volume of 200 ml. The schematic diagram is illustrated in Figure 2.

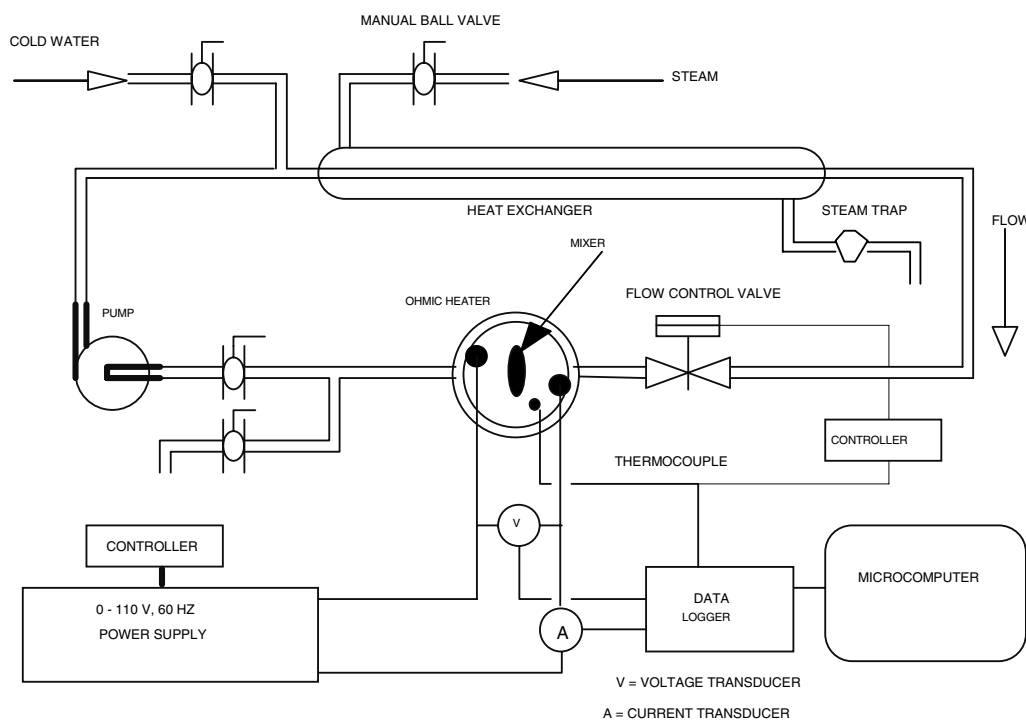

Fig. 1. Schematic of experimental set-up.

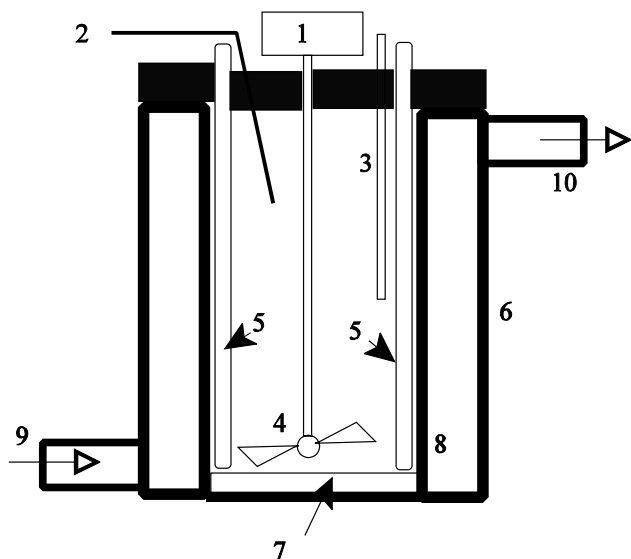

Fig. 2. Schematic of ohmic heater. Key: (1) electrical motor to provide 60 rpm mixing rate; (2) T-type copper constantan, Teflon coated thermocouple; (3) plastic tube for injecting and sampling purposes; (4) mixer made of plastic to provide well-mixed environment; (5) electrodes: stainless steel cylinder electrodes (dia. 0.6 cm). Electrochemical surface area ~ 50 cm²; (6) outer cylindrical tube (dia. 7.5 cm); (7) rubber seal; (8) removable inner stainless steel tube (dia. 5.0 cm) coated three times with epoxy resin (Epoxy light 6001, Irvine, CA) to provide electrical insulation as well as inertness (dia. after coating 4.46 cm); (9) inlet of cooling or heating medium; (10) outlet of the cooling or heating medium; and (11) teflon cover.

2.2. Experimental procedure

The buffer solution was prepared as indicated below. The electrical conductivity was varied by changing the NaCl concentration of the buffer solution. The reaction temperature was kept constant in the following manner. For ohmic heating treatments, 200 ml of the buffer solution were continuously stirred inside the ohmic reactor while cold water was circulating through the reactor jacket. During conventional heating treatments, 200 ml of buffer solution was continuously stirred within the same reactor vessel, with the electrical power turned off; and heating was accomplished by heat exchange with hot water in the jacket. The temperature, voltage, and current were recorded every 30 s during the treatment using a data logger. The electrical power was monitored and maintained at the desired level by a manual voltage controller. For the ohmic heating treatments, the following control strategy was found effective in achieving a constant solution temperature. First, the buffer solution temperature was raised to a few degrees above the desired temperature by conventional (steam) heating, then the steam was turned off and the heating medium was drained and replaced gradually by cold water; thus the temperature of the buffer solution gradually decreased to the set-point temperature. Once the set-point was achieved, the ohmic heater was turned on, while the control valve regulated the flow of cold water to maintain the buffer temperature at steady state. If steady state was not reached within three minutes

after turning on the ohmic heating, the buffer solution was discarded to minimize the change of the buffer pH before injecting ascorbic acid. As soon as a steady state temperature was established, 1 ml of 8% L-ascorbic acid solution (C₆H₈O₆, Sigma Chemical Co., St. Louis, Missouri) was injected into the 200 ml buffer solution at time zero. Then, at least five samples were withdrawn at different time intervals up to a maximum of 60 min. Each sample (1 ml) was immediately mixed with 1 ml of 1% metaphosphoric acid (pH 2.0) (Mallinckrodt Chemical Inc. Paris, Kentucky) at 4 °C, to prevent further ascorbic acid degradation and to reduce other forms of ascorbic acid so that only one species, the reduced form (C₆H₈O₆), would predominate at pH 2 for the purpose of analysis. Samples were stored at 4 °C for up to 48 h prior to analysis. It was verified that no significant degradation occurred during this period. After the end of each experimental run, a sample was taken to check the pH. Also, a fresh surface of electrodes was continuously presented to the buffer solution in each run by brushing and cleaning the electrode surfaces to eliminate most of the adherent layers of reaction product which might have interfered with the succeeding run.

2.3. Buffer solution preparation

The buffer solution (1 l amount) was prepared using the following materials: aqueous sodium chloride solution (made from twice-distilled water and NaCl – J.T. Baker Inc., Phillipsburg, NJ – in the ratios 994 g H₂O:2.5 g NaCl; 991 g H₂O:5.0 g NaCl; and 986 g H₂O:10 g NaCl for the 0.25, 0.5 and 1.0% solutions, respectively); dibasic sodium phosphate (2.39 g, J.T. Baker Inc, Phillipsburg, NJ), and citric acid, monohydrate (1.313 g, Jenneile Enterprises, Cincinnati, OH). All solutions had an initial pH of 3.5 ± 2.5 .

2.4. Ascorbic acid analysis

Ascorbic acid was estimated by a high performance liquid chromatography technique using a Bio-Rad system, (Bio-Rad Labs, Richmond, CA). The system consisted of a Bio-Rad pump, model 1350; detector, model 1706 UV/vis; and connected to an HP data integrator (model 3394, Hewlett-Packard, Avondale, PA). The chromatography column was a Microsorb-300A type C18, size 4.5 × 250 mm (Rainin Instrument Co. Inc., Woburn, MA) with a mobile phase of 10% methanol, 90% HPLC grade water (Fisher Chemical, Fairlawn, NJ) containing 0.1% of 0.85 M phosphoric acid (Fisher Chemical, Fairlawn, NJ), at a 1 ml min⁻¹ flow rate. The absorbance wavelength of the detector was set at 244 nm [16].

Following all heat treatments, ascorbic acid samples were filtered through a 0.45 μm Acrodisc HT tyffryn syringe filter (Gelman Sciences, Ann Arbor, MI) to remove possible solid contaminants. From each filtrate, two samples (50 μl each) were injected into the Bio-Rad system. The system was calibrated with standard test

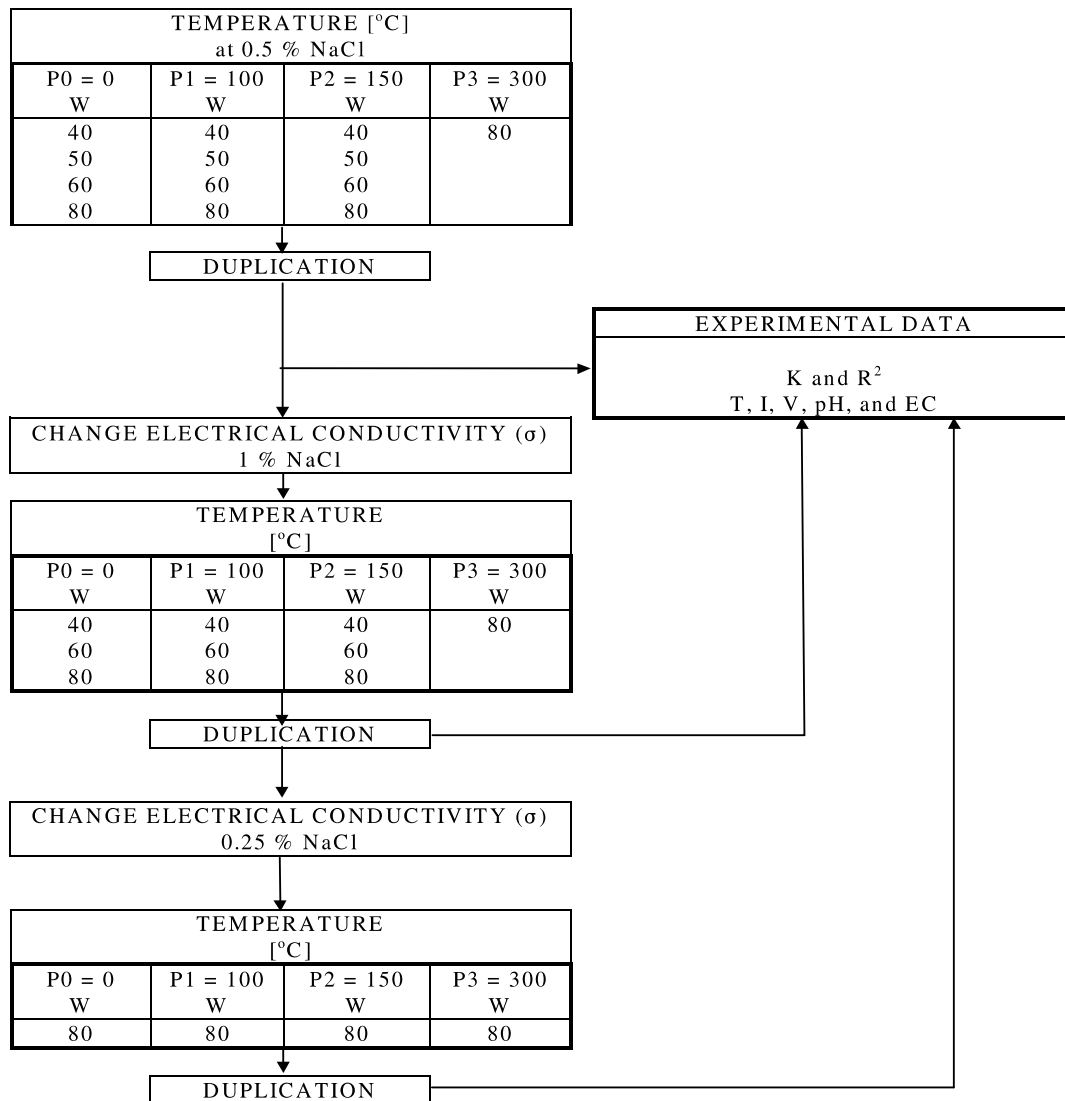

Fig. 3. Experimental flow chart.

solutions of ascorbic acid, and showed a linear relationship with a concentration of ascorbic acid up to 0.08%.

2.5. Data analysis

The entire set of experiments was performed in the sequence shown by the experimental flow chart in Figure 3. After accomplishing all the desired treatments in one category, the entire series was duplicated. The pseudo-first order rate constant for degradation (*k*) was obtained for each treatment by performing linear regression of ln(*C*₀/*C*) against time.

3. Results

3.1. Reaction rate order

The rate of ascorbic acid degradation can be described by a first order model for both conventional and ohmic

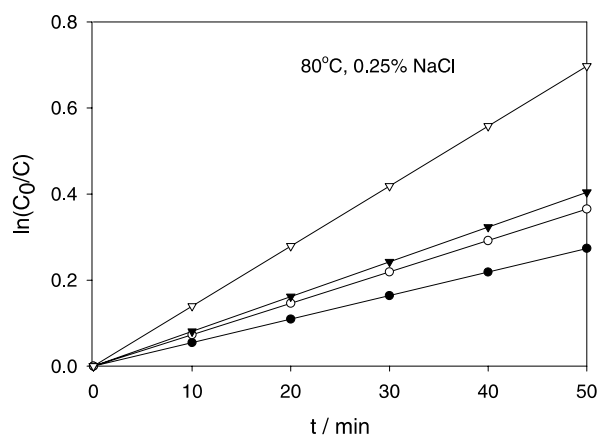

Fig. 4. Sample data fitted by first order model at 80 °C and 0.25% NaCl. Key: (●) 0, (○) 100, (▼) 150 and (▽) 300 W.

heating. Typical data and regression lines are shown in Figure 4. The rate constant for degradation was determined for each experimental run and averaged for each

Table 1. Summary of the experimental results, at pH 3.5 and using uncoated stainless steel electrodes

NaCl /%	Temperature /°C	Current /A	Voltage /V	k /min ⁻¹	R^2
0.25	79.9	0	0	0.00536	0.97
	80.4	2.98	33.03	0.00562	0.93
	80.6	3.66	40.35	0.00727	0.96
	80.6	5.26	57.18	0.01237	0.97
0.5	39.6	0	0	0.00409	0.97
	49.5	0	0	0.00420	0.99
	59.4	0	0	0.00595	0.99
	79.4	0	0	0.00886	0.95
	40.8	2.85	34.27	0.00215	0.95
	49.8	3.07	32.28	0.00254	0.97
	59.5	3.28	30.36	0.00357	0.91
	79.5	3.66	27.20	0.00691	0.96
	40.2	3.45	42.71	0.00685	0.98
	50.0	3.71	39.85	0.00498	0.97
	59.8	3.94	37.76	0.00541	0.92
	79.8	4.43	33.90	0.00814	0.97
	80.3	7.07	41.77	0.00778	0.91
	1.0	40.2	0	0	0.00398
60.0		0	0	0.00633	0.96
79.9		0	0	0.00811	0.98
40.6		3.99	27.03	0.00409	0.81
60.7		5.06	24.26	0.00338	0.87
80.5		5.26	21.76	0.00352	0.81
40.9		4.57	33.21	0.01336	0.85
60.6		5.87	28.72	0.00511	0.81
80.5		7.38	26.27	0.00593	0.88
80.9		7.37	41.16	0.00196	0.93

set of samples that were heat-treated in the same manner, as listed in Table 1.

In general, the coefficient of determination (R^2) values for conventional heating treatments were higher than that under ohmic heating. It was also noted that during ohmic treatments, the pH of the buffer solution increased above its initial value (3.5). These data are summarized in Table 2, where it is clear that the most significant changes occur under relatively low temperatures, high power input, and high salt content conditions.

The higher variability of the ohmically treated samples may be partially explained by the observation that the dissociation constant for ascorbic acid (pK_1 value is 4.2 [17]). Thus, as the pH of the buffer solution increased, it passed through the pK_1 , especially at 1% NaCl, where the stability properties of the undissociated and mono-anionic species of ascorbic acid differs. Thus, under conventional heating, the regression curves $\ln(C_0/C)$ against time fitted the actual data nicely, while the fit was not as good for the samples treated by ohmic heating.

3.2. Effect of temperature

The experimental data were tested for consistency with the Arrhenius relation [$\ln(k) = \ln(k_0) - E_T/RT$] by plotting the natural logarithm of the degradation rate constant, k , against reciprocal temperature as shown in

Table 2. Final pH of samples (average of two replications) following ohmic treatment (initial pH 3.5)

NaCl /%	Temperature /°C	Power /W	Electrical conductivity /mS cm ⁻¹	pH
0.25	80.4	98.5	7.04	3.43
0.25	80.6	148	7.07	3.46
0.25	80.6	301	7.18	3.54
0.5	40.8	97.7	6.49	3.93
0.5	40.2	147	6.30	3.91
0.5	49.8	99.1	7.42	3.97
0.5	50.0	148	7.26	3.95
0.5	59.5	99.7	8.43	3.91
0.5	59.8	149	8.14	3.74
0.5	79.5	99.6	10.5	3.65
0.5	79.8	150	10.2	3.70
0.5	80.3	296	13.2	3.71
1.0	40.6	108	11.5	5.36
1.0	40.9	152	10.7	5.85
1.0	60.7	123	16.3	5.48
1.0	60.6	169	15.9	5.54
1.0	80.5	115	18.9	3.82
1.0	80.5	194	21.9	3.81
1.0	80.9	298	14.4	4.37

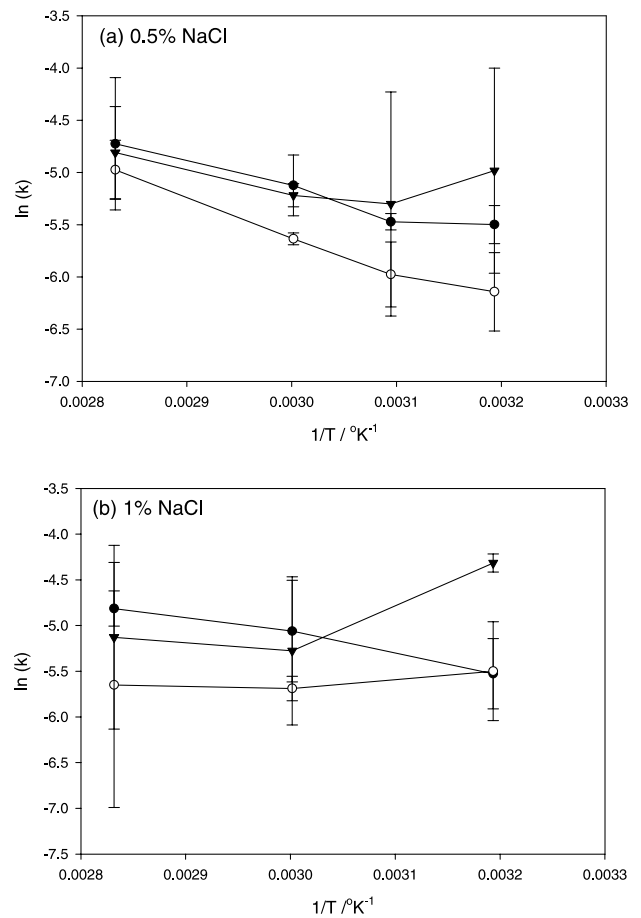

Fig. 5. Arrhenius relation at (a) 0.5% NaCl; (b) at 1.0% NaCl. P_0 = conventional heating, P_1 = 100 W and P_2 = 150 W. Key: (●) P_0 , (○) P_1 and (▼) P_2 .

Figure 5 for 0.5% and 1.0% NaCl. In the case of conventional heating, the Arrhenius relation was

Table 3. Frequency factor (k_0) and temperature coefficient (E_T) of both conventional and ohmic heating treatments for temperature range 40–80 °C, at pH 3.5 and using uncoated stainless steel electrodes

Power /W	NaCl /%	k_0 /min ⁻¹	E_T /kJ mol ⁻¹	R^2
0	0.5	7.09	19.5	0.91
0	1.0	2.41	16.6	0.98
100	0.5	1.31×10^2	29.0	0.98
100	1.0	8.57×10^{-4}	-3.98	0.72
150	0.5	0.318	8.60	0.32
150	1.0	5.63×10^{-6}	-19.9	0.65

followed well over the temperature range. The activation energy (E_T), frequency factor (K_0) and coefficient of determination (R^2) are listed in Table 3 for the purpose of comparison between conventional and ohmic heating. One factor affecting the apparent temperature-sensitivity of ascorbic acid would be the decreasing amount of dissolved oxygen as the temperature increased. Results [14] showed a negative value for E_T , which was attributed to the low concentration of dissolved oxygen at high temperatures. The samples that were heated ohmically did not follow the Arrhenius relation especially at low temperature (40 °C) and high NaCl (1.0%). In fact, the activation energies sometimes had negative values (e.g., 1% NaCl), indicating that factors other than temperature may have taken effect during ohmic heating.

The degradation rate under ohmic heating was not significantly different from that under conventional heating (Figure 6(a)) except at high power (150 W) high NaCl content (1%) and low temperature (40 °C) conditions (Figure 6(b)). Under these conditions the ohmic heating degradation rate was significantly greater than for conventional heating. A plot of the rate constants versus power shows no significant differences, except specific cases under low and high power inputs (Figure 7).

4. Discussion

The degradation of ascorbic acid under ohmic heating conditions may be broken down into the following phenomena:

- (i) Chemical oxidation (either catalysed or uncatalysed) in the manner typical of most heating reactions.
- (ii) Chemical degradation via the anaerobic pathway [18, 19].
- (iii) Electrochemical degradation by reactions at the electrode.

The first two types of degradation are commonly encountered in food processing, but, in the presence of oxygen, oxidative degradation is the dominant mechanism, exceeding by far, the anaerobic degradation rate [18]. The presence of metal ions catalyses the above reaction; in particular, ions such as Fe^{3+} and Cu^{2+} which may accelerate the reaction by several orders of magnitude. In the absence of ohmic heating, it is

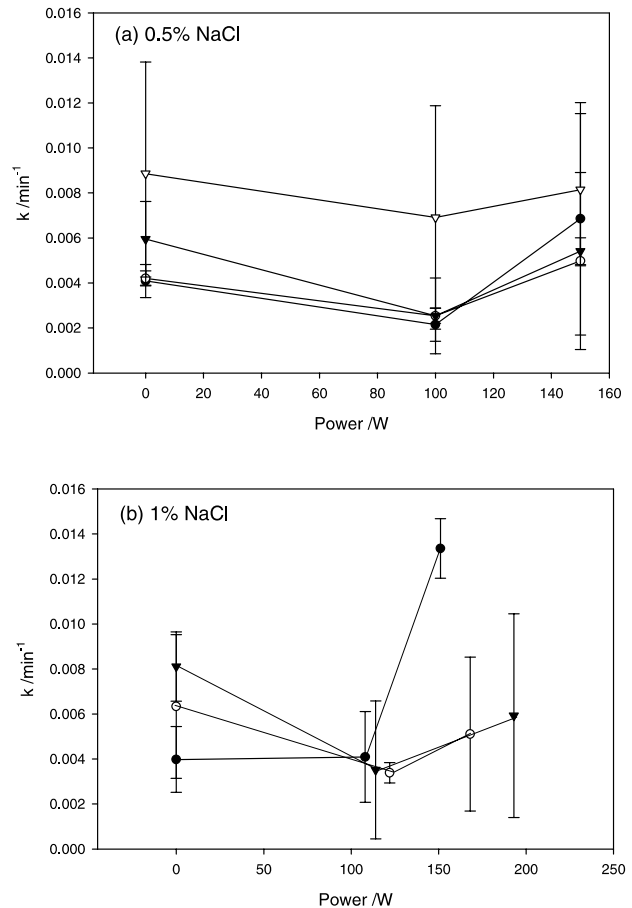

Fig. 6. Effect of conventional and ohmic heating on the rate constant of degradation at different temperatures (a) 0.5% NaCl and (b) 1% NaCl. Key for (a): (●) 40, (○) 50, (▼) 60 and (▽) 80 °C. Key for (b): (●) 40, (○) 60 and (▼) 80 °C.

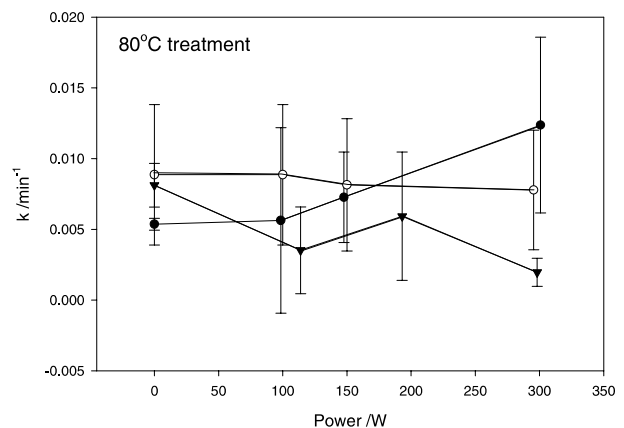

Fig. 7. Effect of applied power on the rate constant for degradation at 80 °C at various NaCl concentrations. Key: (●) 0.25% NaCl, (○) 0.5% NaCl and (▼) 1% NaCl.

expected that these are the dominant degradation mechanisms. The degradation rates are influenced by the solubility of oxygen at the temperature of the reaction. Although Fe^{3+} ions may have been present during conventional heating, via diffusion from the electrodes, the concentration of ferric ions will likely be very small over the duration of the experiment.

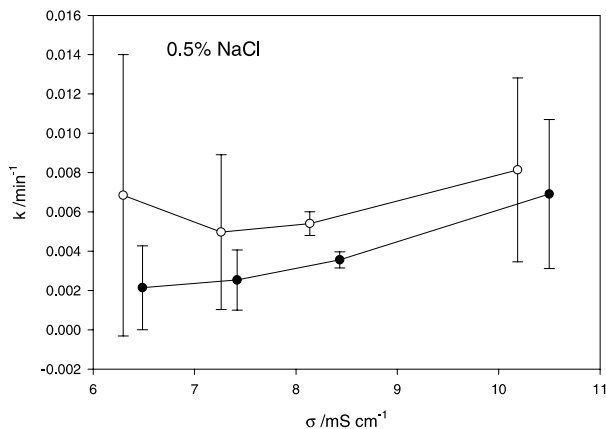

Fig. 8. Rate constant for degradation (k) as affected by power ($P_1 = 100$ W, $P_2 = 150$ W) at 0.5% NaCl (note decreased electrical conductivity at P_2). Key: (●) $P_1 = 100$ W and (○) $P_2 = 150$ W.

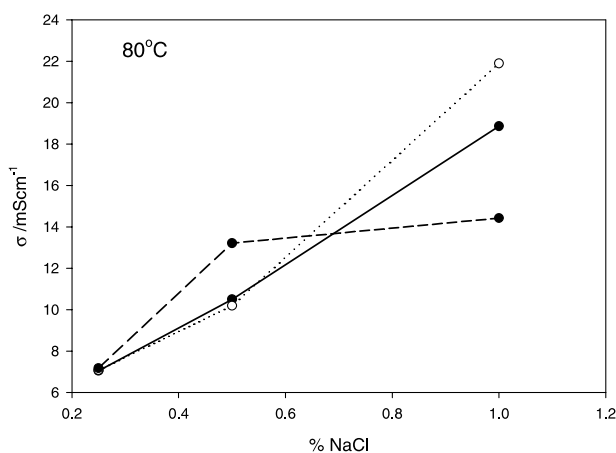
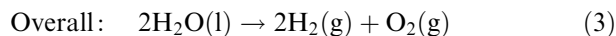
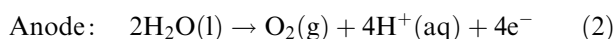
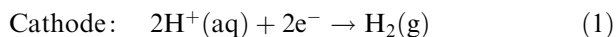

Fig. 9. Change of electrical conductivity at 80 °C as NaCl concentration increases. Key: (●-●) 100, (○-○) 150 and (●- - -●) 300 W.

Under ohmic heating conditions, the third mechanism, electrochemical degradation becomes important, and any differences in reaction rate between conventional and ohmic heating are likely due to this pathway. In the absence of convective transport, such reactions may be localized in the electrode vicinity; however, our reactor was stirred, thus some of the products of electrolysis may have been dispersed into the bulk, where further reactions may have occurred. Such transport notwithstanding, it is likely that the microenvironment in the electrode vicinity differed markedly from that in the bulk.

A complete and detailed delineation of all possible reactions is beyond the scope of this work, however, it is possible to discuss some of the important reactions that may influence the degradation of ascorbic acid:

(a) Electrolysis of water, yielding hydrogen at the cathode, and oxygen at the anode.



Since the voltage is alternating, both products may be released at each electrode. The molecular oxygen generated by water electrolysis causes additional oxidation of ascorbic acid. We note that if arcing or other such discharges were to occur, that the formation of singlet oxygen and a major increase in oxidation rate are possible [20]. However, we do not expect that singlet oxygen is produced in our system, since dielectric breakdown did not occur.

(b) Electrode corrosion, either by direct metal oxidation (as shown below) or by electrochemical generation of corroding chemicals. In particular, for stainless steel electrodes, the following reactions could occur:

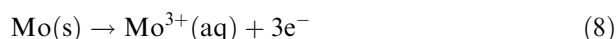
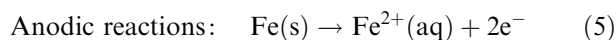
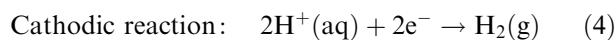

The metal ions migrating into the medium can be further oxidized and undergo other secondary reactions. In particular, Fe^{2+} and Fe^{3+} ions in the solution would serve to catalyse the oxidation of ascorbic acid. Indeed, even if conditions were anaerobic, Fe^{3+} ions retain catalytic activity independent of oxygen concentration [18].

The net effect of the above reactions is complex, and depends on the specific interactions that are favoured under the conditions of experiment. Nevertheless, some of our experimental observations may be explained by the above processes. For example, we noticed a brown color to the solution, indicating the presence of ferric chloride. Insoluble brown deposits were also seen on electrode surfaces, indicating the possible formation of iron(III) oxide or iron chloride.

To investigate this point further, we analysed the deposit to determine its chemical composition using scanning electron microscopy – energy dispersive X-ray spectroscopy (SEM-EDS). The quantitative distribution of elements were as shown in Table 4. The results indicated that the elements Fe, Cr, Ni, Mo, Mn, Si and P (present within stainless steel electrodes) are found in the deposit. The increase in phosphorus fraction from less than 0.1% in the electrodes to 6.94% in the deposit, indicates the formation of metal phosphates from the solution. Some metal chlorides are also apparently formed. Although the amount of oxygen is large, it is not possible to distinguish whether this was due to the formation of oxides and phosphates, or due to absorbed water that hydrated these deposits. Still, the occurrence of oxides is likely. The ingredients of the McIlvaine citric

Table 4. Composition of elements in electrode deposits determined using SEM-EDS (results in atomic percentages)

Element	Percentage in deposit
O	74.7
Na	2.62
Si	0.31
P	6.94
Cl	0.64
Mn	0.43
Fe	11.55
Ni	0.71
Cr	2.15
Mo	0.78

phosphate buffer used in our study are frequently used in food formulations. In particular, citric acid is a well-known chelating agent, and is used to inhibit lipid oxidation in foods which might be accelerated by some metal ions. The electrode corrosion yields metal ions which then form chelated complexes with citric acid. The formation constants for metal complexes with organic ligands is far greater than that with chlorides [21]. Once the free citric acid is utilized for such reactions, the buffering capacity of the solution is lost, and the pH of the buffer would be expected to increase rapidly. This appears to be a reason for the significant pH increase during some of the ohmic heating treatments. Notably, this occurs under conditions of relatively low temperature and high power input. Under these conditions, large amounts of electrode metal ions may find their way into solution, forming citrate complexes and increasing the pH.

To verify this point, we analysed the solution from an ohmic heating test with 1% NaCl at 300 W, for Fe(III) citrate formation by two independent analytical techniques, spectrophotometry and electrospray ionization mass spectrometry (ESI-MS). Both sets of analyses revealed the presence of Fe(III) citrate in the solution. The system was also found to initially contain phosphate in the form of NaH_2PO_4 . The solubility products (K_{sp}) of Fe, Cr and Ni-phosphates are highly insoluble in an aqueous medium; thus metal phosphates would be expected to be deposited on electrodes. This is supported by our SEM-EDS results for analysis of deposits, which showed the presence of phosphorus in the deposit. This chelation would be expected to lower the buffering capacity of the solution and contribute to the rise in pH.

We also verified that buffering capacity was, in fact, lowered, by conducting two separate sets of experiments. In the first procedure, buffer solutions with and without metal ions (e.g., FeCl_3 , with pH adjusted to the same value as the buffer) were heated at 80 °C for 60 min, and allowed to cool. Buffer capacity (β) and pH were measured for each sample, before and after each treatment. In the second set of experiments, ascorbic acid was mixed in buffer solution with or without Fe^{3+} ions (as FeCl_3). Both samples were adjusted to the same pH, and heated ohmically at 80 °C for 60 min. Buffer capacities (at 80 °C) and pH (at 25 °C) were measured after the heating period. The results of both sets of experiments, tabulated together in Table 5 show that when ascorbic acid is added, the buffer solution is strengthened in comparison to buffer alone, and that buffer capacities were reduced in the presence of metal ions. For the samples with ascorbic acid or ascorbic acid and metal ions, the decrease in buffering capacity during ohmic heating is greatest at the highest power input (300 W). It may also be noted that the greatest decrease in buffering capacity is for the 300 W, 1% NaCl treatment. A pH increase of 0.94 units was observed for this treatment (the highest among all treatments that included ascorbic acid and metal ions).

These results show that metal-citrate complexation lowers buffer capacity during ohmic heating, contributing to a pH increase. Further analysis (by GC-MS) of the buffer solution before and after ohmic (300 W, 1% NaCl) heating to 80 °C, showed that more than 99% of citric acid and phosphates were lost in comparison to conventional heating at the same temperature. With such a loss of buffering components, a change in pH is hardly surprising.

The trends in ascorbic acid degradation may be influenced by a complex interaction of the above reactions. Our analysis of deposits suggests that oxide formation is likely. At high power levels, oxidation of iron may serve to use the available oxygen. This, together with a loss in buffering capacity and a pH increase would affect ascorbic acid degradation kinetics.

4.1. Prediction of the rate constant for degradation

The rate constant for ascorbic acid degradation can be predicted by the following regression model, where all variables were significant ($p < 0.005$), and $R^2 = 0.92$;

Table 5. Buffer capacities (β) and pH changes in buffer solutions, solutions with ascorbic acid (AA), and solutions with ascorbic acid and metal ions, following ohmic heating treatments for various NaCl concentrations and power levels

NaCl conc. w/v/%	Power /W	β buffer solution	pH change, buffer solution	β buffer + Fe^{3+} ions	pH change, buffer + Fe^{3+} ions	β buffer + AA + Fe^{3+} ions	pH change, buffer + AA + Fe^{3+} ions
0.25	100	4.83 ± 0.25	0.05	4.36 ± 0.20	-0.07	5.72 ± 0.53	-0.04
0.25	150	4.83 ± 0.25	0	4.43 ± 0.26	-0.05	5.46 ± 0.31	-0.09
0.5	150	4.77 ± 0.16	0.17	4.14 ± 0.25	-0.08	5.52 ± 0.40	+0.06
1.0	300	4.82 ± 0.10	3.9	3.29 ± 0.32	-0.24	4.57 ± 0.54	+0.94

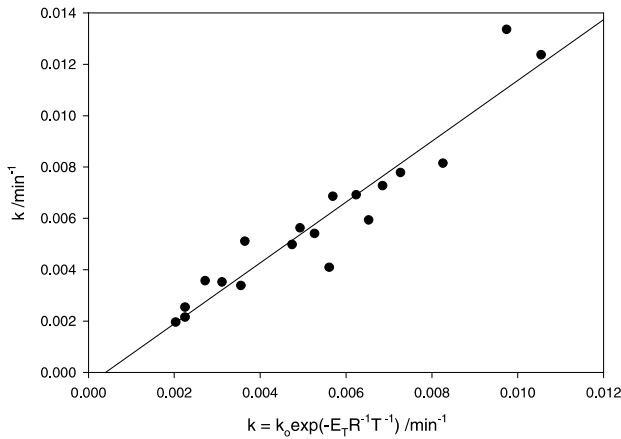

Fig. 10. Actual data as fitted by regression model, Equation 9.

$$\ln(k) = \ln(k_0) - (E_T/RT) \quad (9)$$

$$k_0 = 3.7735 [\text{NaCl}]^{-13.2} \exp([\text{NaCl}]^2) I^{-12.92} (E_T/R) \\ = -32718 + 246 V - 1.44 V^2 + 25823(I/V) \\ + 26876 [\text{NaCl}]$$

where the above correlation and the real data points are illustrated in Figure 10. The limitations of the above model are $40 < T < 80$ °C, $100 < P < 300$ W, and $0.25 < [\text{NaCl}] < 1$ (g (100 ml)⁻¹). Equation 9 is an empirical relation, which is not applicable outside these sets of conditions, but it is included in the hope that it provides an approximate predictor of reaction rate constants for the degradation of ascorbic acid.

In light of these experimental results, it is reasonable to assume that the type of electrode material, solvent, pH, type of electrolyte, and applied voltage might significantly alter the reactions during food processing. In particular, the incidence of Faradaic reactions [5] appear to play a significant role in this case. Thus, the question arises as to what affects oxygen concentration in ohmically processed food with so many variables. Basically, oxygen seemed to be generated by electrolysis and partially consumed by the corrosion reaction. Although it appears that the formation of oxides at the electrode can limit oxygen availability for ascorbic acid oxidation, such an option is unappealing when considering that the processed product may be edible. Perhaps, electrode corrosion can be limited using inert coatings, high corrosion resistant metal, or maybe, changing the reaction environment such as pH. Using highly corrosion-resistant electrodes or changing the reaction environment remain to be investigated in detail. The studies of Tzedakis et al. [6] suggest that for real food systems on a pilot scale, platinized titanium electrodes may be a worthwhile option.

Even if it is possible to improve the stability of the electrodes, the electrolysis (gas evolution) reaction remains a problem that needs to be minimized. Most processed food materials contain a high percentage of water, which can be easily electrolyzed during ohmic

heating, causing oxygen evolution [22]. Minimization of Faradaic reactions by the choice of high capacitance porous electrodes may be hindered by the possibility that bacterial colonies or proteinaceous materials may adhere to interstitial spaces within electrodes. Another option, the use of high frequency alternating currents, is an increasingly attractive possibility, given the recently lowered cost of such supplies.

The principal purpose of our study was to examine ascorbic acid degradation in a simple buffer system, and attempt to explain some of the phenomena in the ohmic heating situation. A more detailed follow-up study should attempt to quantify and characterize specific reactions occurring at the electrodes. We further note that a real food system is considerably more complex than the simple buffer system used herein, and should be the subject of separate studies.

5. Conclusions

Degradation of ascorbic acid during ohmic heating, using stainless steel electrodes, can be described by a first order model. The destruction rate during conventional heating is different than that during ohmic heating with the latter not being described by the Arrhenius relation. Electrolysis and electrode corrosion reactions influence the degradation rate. In particular, the formation of oxides appears to consume electrogenerated oxygen, making it unavailable for ascorbic acid oxidation. Further, metal-citrate complexation results in lost buffering capacity and increased pH, depending on the applied power and the NaCl concentration. Thus, changing the initial pH of the buffer solution might result in a different pattern of ascorbic acid degradation. These results are for a model buffer solution only, and may not apply to the more complex real food system.

Acknowledgements

Salaries and Research Support provided in part by the Ohio Agricultural Research and Development Center (OARDC), The Ohio State University. References to commercial products and trade names are made with the understanding that no endorsement or discrimination by The Ohio State University are implied.

References

1. C.H. Biss, S.A. Coombes and P.J. Skudder, in R.W. Field and J.A. Howell (Eds), 'Process Engineering in the Food Industry' (Elsevier, 1989), p. 17.
2. G.V. Barbosa-Cánovas, M. Gongora-Nieto, U. Pothakamury and B. Swanson, 'Processing of Foods with Pulsed Electric Fields' (Academic Press, 1999).
3. A.A.P. de Alwis and P.J. Fryer, *Chem. Eng. Sci.* **45** (1990) 1547.
4. S.K. Sastry, *J. Food Proc. Engr.* **15** (1992) 263.

5. C. Amatore, M. Berthou and S. Hebert, *J. Electroanal. Chem.* **457** (1998) 191.
6. T. Tzedakis, R. Basseguy and M. Comtat, *J. Appl. Electrochem.* **29** (1999) 821.
7. A.E. Bender, 'Nutritional Changes in Food Processing, Developments in Foods Preservation', Vol. 4 (Elsevier, 1987), p. 1.
8. J.F. Gregory III, in T. Richardson (Ed), 'Chemical changes of vitamins during food processing' (AVI, 1985).
9. M.H. Eison-Perchonok and T.W. Downes, *J. Food Sci.* **47** (1982) 765.
10. Y.C. Lee, J.R. Kirk, C.L. Bedford and D.R. Heldman, *J. Food Sci.* **42** (1977) 640.
11. D.B. Dennison and J.R. Kirk *J. Food Sci.* **43** (1978) 609.
12. I. Saguy, I.J. Kopelman and S.J. Mizrahi, *J. Food Proc. Engr.* **2** (1978) 213.
13. N.S. Kincal and C. Giray, *Int. J. Food Sci. and Technol.* **22** (1987) 249.
14. B.M. Laing, D.L. Schlueter and T.P. Labuza, *J. Food Sci.* **43** (1978) 1440.
15. S. Palaniappan, S.K. Sastry and E.R. Richter, *Biotech. & Bioeng.* **39** (1992) 225.
16. R. Howard, T. Peterson and P. Kastl, *J. Chrom.* **414** (1987) 434–439.
17. C. Zapsalis and R.A. Beck, 'Food Chemistry and Nutritional Biochemistry' (Wiley, New York, 1986).
18. S.R. Tannenbaum, V.R. Young and D. Lorient, in O. Fennema (Ed), 'Food Chemistry' (Marcel Dekker, 1976), p. 477.
19. T.P. Coultate, 'Food: the Chemistry of its Components' (Royal Society of Chemistry, 1996).
20. R.P. Wayne, in A.A. Frimer (Ed), 'Singlet O₂ Vol. I. Physical-Chemical Aspects' (CRC, 1985), p. 82.
21. J.A. Dean (Ed), 'Lange's Handbook of Chemistry', (McGraw-Hill, 13th edn, 1985).
22. J. Ko'nya, *J. Electrochem. Soc.* **126** (1979) 54.